



Brewery Chillers



Legacy Chillers, Inc.
851 Tech Drive
Telford, PA 18969
Toll-Free: (877) 988-5464

Model: **PZATB13D**

Packaged Air-Cooled 13 HP Brewery Chiller

with Stainless Steel Tank

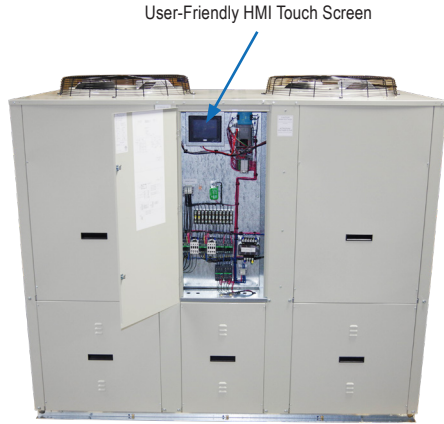

User-Friendly HMI Touch Screen

Front Side View



Back/Side View

Process Fluid Outlet

Process Fluid Inlet

STANDARD ON ALL LEGACY MODELS:
Pentra Microsmart, Programmable Logic Controller (PLC) with HMI Touch Screen Display.

**R454C
Refrigerant**

Standard Features:

- Conforms to UL 60335-2-40:2022 Ed.4
- UL60335-1:2016 Ed.6
- CSA C22.2 # 60335-1:2016 Ed.2
- CSA C22.2 # 60335-2-40:2022 Ed.4
- Single point power connection
- Pentra Microsmart, Programmable Logic Controller (PLC) with easy to use HMI touch screen display
- Door Mounted HMI with weather proof cover
- 5 Port Ethernet Switch (Chiller remote network access control and Modbus capability)
- Remote SMTP services for email alerts
- STAINLESS STEEL Tank
- STAINLESS STEEL Process Pump
- Pump Isolation Valves
- Fused, STAINLESS STEEL evaporator pump
- STAINLESS STEEL, brazed plate evaporator
- Scroll compressor with crankcase heater
- Suction accumulator
- Liquid line drier, sight glass, solenoid
- Electronic expansion valve
- Manual high pressure cutout
- Fluid flow switch
- 24V control transformer
- Direct drive condenser fan motor
- Rust resistant, high CFM, aluminum condenser fan blade
- Condenser(s): copper tube/aluminum fin
- Compressor motor contactor
- Condenser motor and control circuit fusing
- Painted (Powder Coat), galvanized sheet metal cabinet
- 1/2" insulation on all fluid and Low pressure refrigerant lines
- Complete refrigerant charge from factory
- Factory performance test prior to shipment



Options:

- Remote Idec touchscreen control panel
- BacNet Gateway
- Process Pump VFD Controller
- Condenser Fan VFD Controller
- Compressor VFD Controller
- 4 year extended compressor warranty
- Casters (factory mounted)
- 115 volt (rain tight) service outlet
- Non Fused Disconnect
- Phase Monitor, line voltage monitor offering protection against phase loss/reversal, unbalance and High/Low voltage
- Compressor fusing
- Compressor Sound Cover
- Flooded cond. w/receiver/head pressure control (0°F)
- Heated, flooded cond. w/receiver/head pressure control (-20°F)
- Water flow meter
- Low flow bypass
- Dual process pump with auto changeover
- Pump suction isolation valve
- Water pressure gauge set
- Coastal powder coat paint protection
- E-Coat Condenser Coil (coastal protection)
- Storage tank sight glass

LEGACY CHILLERS, INC. – PRODUCT DATA SHEET



Brewery Chillers



Legacy Chillers, Inc.
 851 Tech Drive
 Telford, PA 18969
 Toll-Free: (877) 988-5464

Model: **PZATB13D**

Packaged Air-Cooled 13 HP Brewery Chiller

Product Dimensional Drawing

© Property of Legacy Chillers, Inc.

with Stainless Steel Tank

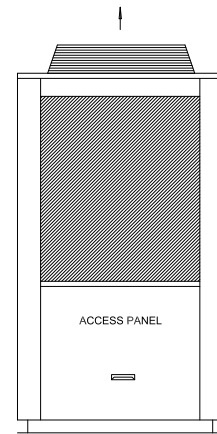
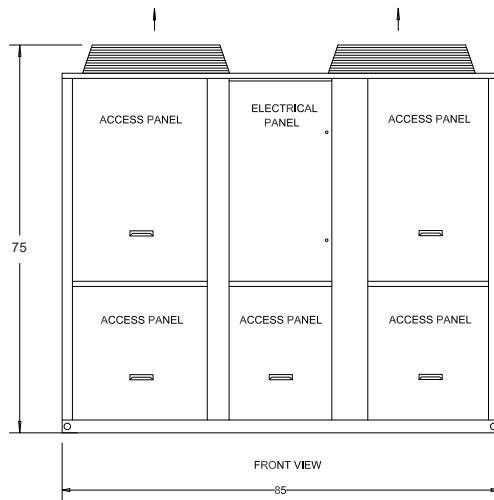
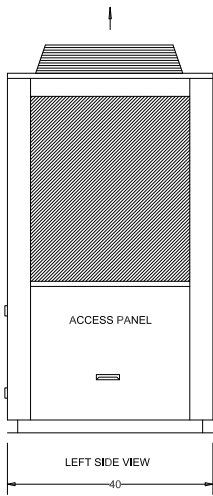
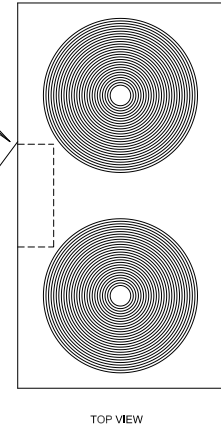
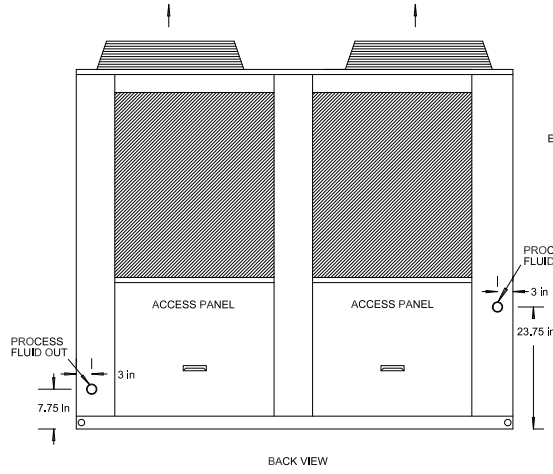
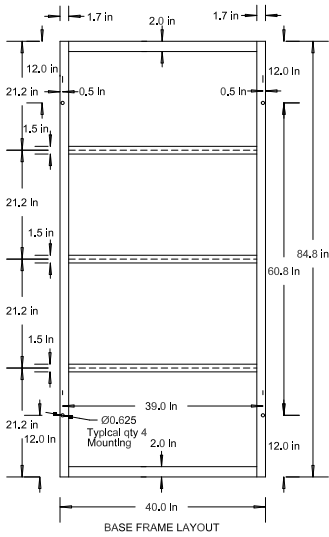

Dimensional & Electrical Table (Dual Circuit)

Chiller System	Brewery Model	Capacity (90°F Ambient)		Glycol Pump (HP)	Tank	Dimensions			Ship Weight	Operating Weight	Electrical Data			Glycol Fitting Connections
		28°F Glycol	33°F Glycol			Length	Width	Height			Voltage / Phase / HZ	MCA	MOP	
13 HP	PZATB13DF8	117600	131200	3	120	85	40	75	1895	2700	208/230-3-60	84	110	1 1/2"
	PZATB13DH8										460-3-60	33	45	
	PZATB13DI8										575-3-60	28	35	

LEGACY CHILLERS, INC. – PRODUCT DATA SHEET