



# Brewery Chillers



**Legacy Chillers, Inc.**  
851 Tech Drive  
Telford, PA 18969  
Toll-Free: (877) 988-5464

**LEGACY CHILLERS, INC. – PRODUCT DATA SHEET**

## Model: IEZATB13D Split-System Air-Cooled 13 HP Brewery Chiller



**R454C Refrigerant**

**with Stainless Steel Tank**

**STANDARD ON ALL LEGACY MODELS:**  
Pentra Microsmart, Programmable Logic Controller (PLC) with HMI Touch Screen Display.

Also comes with - Outside Condenser Model (OC13D)

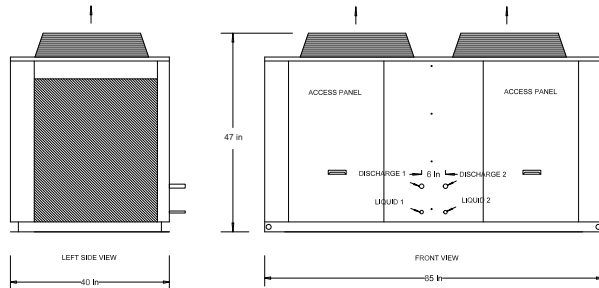

**OC Refrigerant Connections:** Discharge Line- 7/8" (2), Liquid Line- 1/2" (2)

### Standard Features:

- **Conforms to UL 60335-2-40:2022 Ed.4**  
**UL 60335-1:2016 Ed.6**
- CSA C22.2 # 60335-1:2016 Ed.2
- CSA C22.2 # 60335-2-40:2022 Ed.4
- **Single point power connection**
- **Pentra Microsmart, Programmable Logic Controller (PLC) with easy to use HMI touch screen display**
- **Door Mounted HMI with weather proof cover**
- **5 Port Ethernet Switch** (Chiller remote network access control and Modbus capability)
- **Remote SMTP services for email alerts**
- **STAINLESS STEEL Tank**
- **STAINLESS STEEL Process Pump**
- **Pump Isolation Valves**
- **Fused, STAINLESS STEEL evaporator pump**
- **STAINLESS STEEL, brazed plate evaporator**
- **Scroll compressor with crankcase heater**
- **Suction accumulator**
- **Liquid line drier, sight glass, solenoid**
- **Electronic expansion valve**
- **Manual high pressure cutout**
- **Fluid flow switch**
- **24V control transformer**
- **Direct drive condenser fan motor**
- **Rust resistant, high CFM, aluminum condenser fan blade**
- **Condenser(s): copper tube/aluminum fin**
- **Compressor motor contactor**
- **Condenser motor and control circuit fusing**
- **Painted (Powder Coat), galvanized sheet metal cabinet**
- **1/2" insulation on all fluid and Low pressure refrigerant lines**
- **Complete refrigerant charge from factory**
- **Factory performance test prior to shipment**



### Options:

- **Compressor VFD Controller**
- **Remote Idec touchscreen control panel**
- **BacNet Gateway**
- **Process Pump VFD Controller**
- **Condenser Fan VFD Controller**
- **4 year extended compressor warranty**
- **Casters (factory mounted)**
- **115 volt (rain tight) service outlet**
- **Non Fused Disconnect**
- **Phase Monitor, line voltage monitor offering protection against phase loss/reversal, unbalance and High/Low voltage**
- **Compressor fusing**
- **Compressor Sound Cover**
- **Flooded cond. w/receiver/head pressure control (0°F)**
- **Heated, flooded cond. w/receiver/head pressure control (-20°F)**
- **Water flow meter**
- **Low flow bypass**
- **Dual process pump with auto changeover**
- **Pump suction isolation valve**
- **Water pressure gauge set**
- **Coastal powder coat paint protection**
- **E-Coat Condenser Coil (coastal protection)**
- **Storage tank sight glass**



# Brewery Chillers



**Legacy Chillers, Inc.**  
 851 Tech Drive  
 Telford, PA 18969  
 Toll-Free: (877) 988-5464

Model: **IEZATB13D**

## Split-System Air-Cooled 13 HP Brewery Chiller

### Product Dimensional Drawing

© Property of Legacy Chillers, Inc.

*with Stainless Steel Tank*

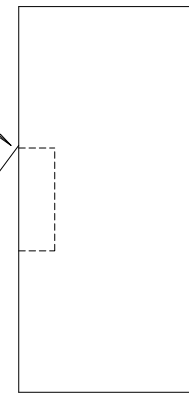
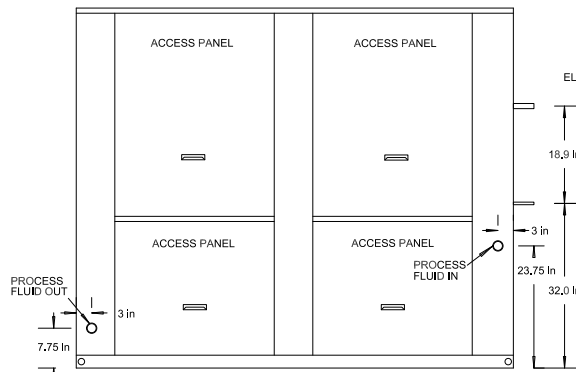
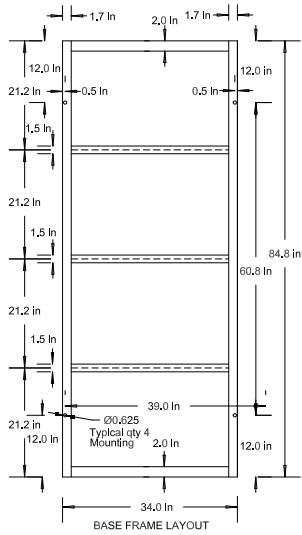

BACK VIEW

TOP VIEW

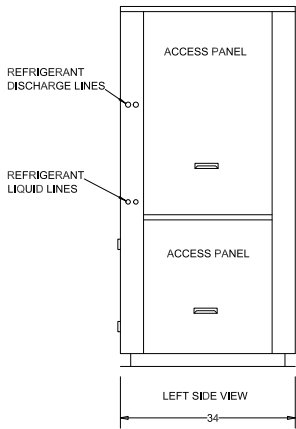

LEFT SIDE VIEW

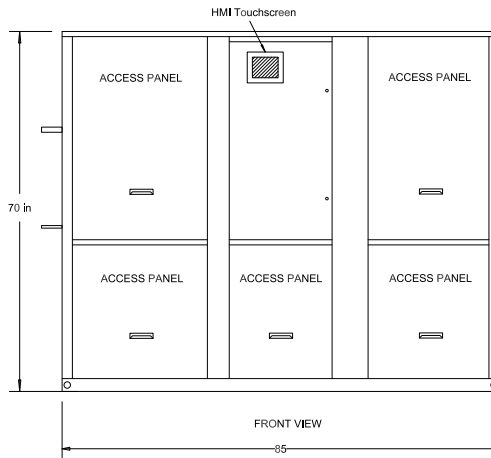

FRONT VIEW

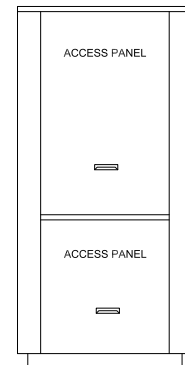

### Dimensional & Electrical Table (Dual Circuit)

Chiller System	Brewery Model	Capacity (90°F Ambient)		Glycol Pump (HP)	Tank	Dimensions			Ship Weight	Operating Weight	Electrical Data			Glycol Fitting Connections
		28°F Glycol	33°F Glycol			Length	Width	Height			Voltage / Phase / HZ	MCA	MOP	
13 HP	IEZATB13DF8	117600	131200	3	120	85	34	70	1895	2700	208/230-3-60	84	110	1 1/2"
	IEZATB13DH8										460-3-60	33	45	
	IEZATB13DI8										575-3-60	28	35	

LEGACY CHILLERS, INC. – PRODUCT DATA SHEET