



# Brewery Chillers



**Legacy Chillers, Inc.**  
851 Tech Drive  
Telford, PA 18969  
Toll-Free: (877) 988-5464

**LEGACY CHILLERS, INC. – PRODUCT DATA SHEET**

## Model: IEZATB12S Split-System Air-Cooled 12 HP Brewery Chiller

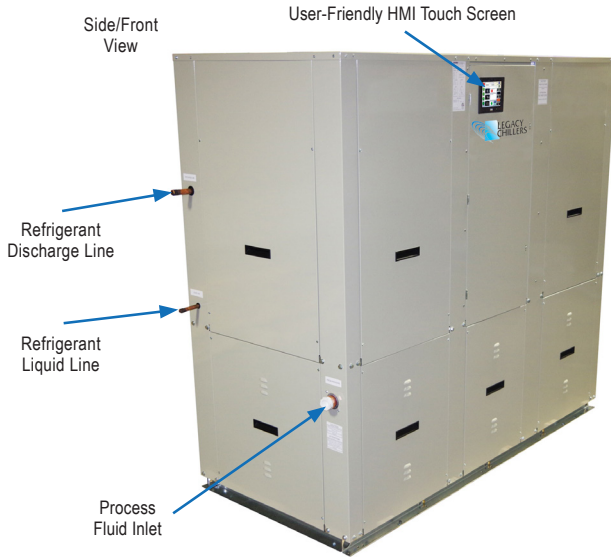

**R454A Refrigerant**

**with Stainless Steel Tank**

**STANDARD ON ALL LEGACY MODELS:**  
Pentra Microsmart, Programmable Logic Controller (PLC) with HMI Touch Screen Display.

Also comes with - Outside Condenser Model (OC12S)

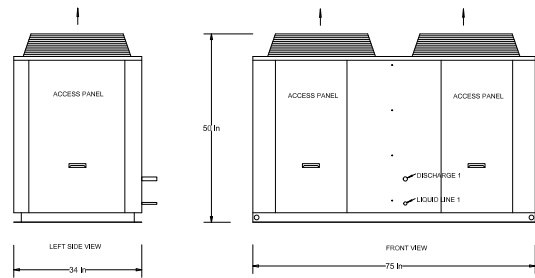

**OC Refrigerant Connections:** Discharge Line- 1 1/8", Liquid Line- 5/8"

### Standard Features:

- **Conforms to UL 60335-2-40:2022 Ed.4**  
**UL 60335-1:2016 Ed.6**
- CSA C22.2 # 60335-1:2016 Ed.2
- CSA C22.2 # 60335-2-40:2022 Ed.4
- **Single point power connection**
- **Pentra Microsmart, Programmable Logic Controller (PLC) with easy to use HMI touch screen display**
- **Door Mounted HMI with weather proof cover**
- **5 Port Ethernet Switch** (Chiller remote network access control and Modbus capability)
- **Remote SMTP services for email alerts**
- **STAINLESS STEEL Tank**
- **STAINLESS STEEL Process Pump**
- **Pump Isolation Valves**
- **Fused, STAINLESS STEEL evaporator pump**
- **STAINLESS STEEL**, brazed plate evaporator
- **Scroll compressor with crankcase heater**
- **Suction accumulator**
- Liquid line drier, sight glass, solenoid
- Electronic expansion valve
- Manual high pressure cutout
- **Fluid flow switch**
- **24V control transformer**
- Direct drive condenser fan motor
- Rust resistant, high CFM, aluminum condenser fan blade
- Condenser(s): copper tube/aluminum fin
- Compressor motor contactor
- Condenser motor and control circuit fusing
- **Painted (Powder Coat), galvanized sheet metal cabinet**
- 1/2" insulation on all fluid and Low pressure refrigerant lines
- Complete refrigerant charge from factory
- **Factory performance test prior to shipment**



### Options:

- **Compressor VFD Controller**
- **Remote Idec touchscreen control panel**
- **BacNet Gateway**
- **Process Pump VFD Controller**
- **Condenser Fan VFD Controller**
- 4 year extended compressor warranty
- Casters (factory mounted)
- 115 volt (rain tight) service outlet
- Non Fused Disconnect
- Phase Monitor, line voltage monitor offering protection against phase loss/reversal, unbalance and High/Low voltage
- Compressor fusing
- Compressor Sound Cover
- Flooded cond. w/receiver/head pressure control (0°F)
- Heated, flooded cond. w/receiver/head pressure control (-20°F)
- Water flow meter
- Low flow bypass
- Dual process pump with auto changeover
- Pump suction isolation valve
- Water pressure gauge set
- Coastal powder coat paint protection
- E-Coat Condenser Coil (coastal protection)
- Storage tank sight glass



# Brewery Chillers



**Legacy Chillers, Inc.**  
 851 Tech Drive  
 Telford, PA 18969  
 Toll-Free: (877) 988-5464

Model: **IEZATB12S**

## Split-System Air-Cooled 12 HP Brewery Chiller

### Product Dimensional Drawing

© Property of Legacy Chillers, Inc.

*with Stainless Steel Tank*

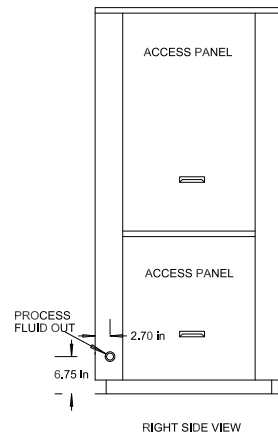
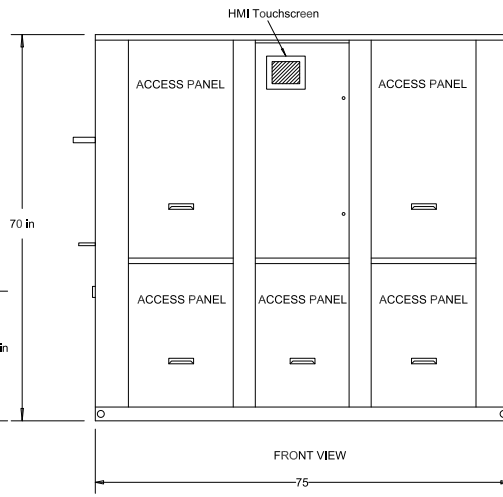
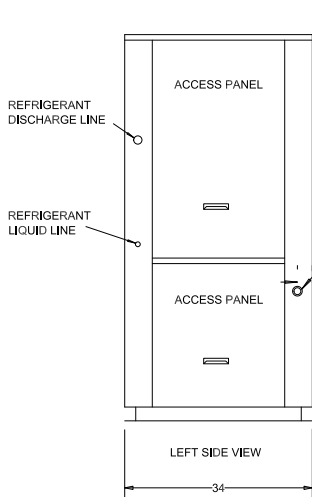
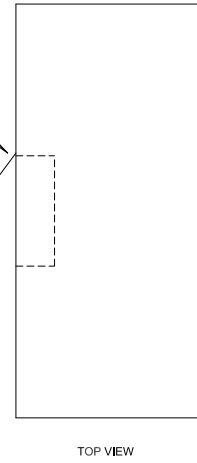
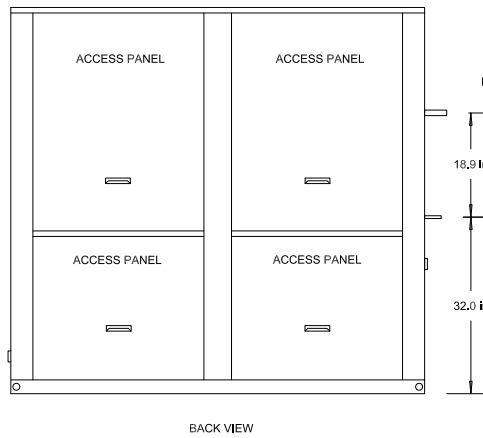
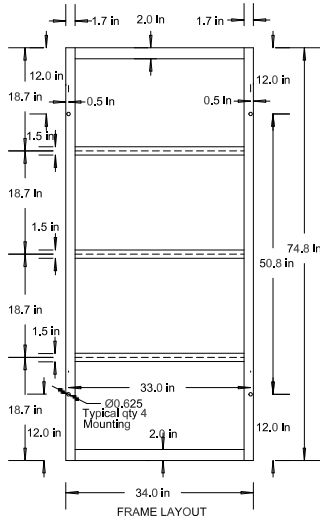

### Dimensional & Electrical Table (Single Circuit)

Chiller System	Brewery Model	Capacity (90°F Ambient)		Glycol Pump (HP)	Tank	Dimensions			Ship Weight	Operating Weight	Electrical Data			Glycol Fitting Connections
		28°F Glycol	33°F Glycol			Length	Width	Height			Voltage / Phase / HZ	MCA	MOP	
12 HP	IEZATB12SF7	115100	128400	2	80	75	34	70	1400	1840	208/230-3-60	72	110	1 1/2"
	460-3-60										32	50		
	575-3-60										29	45		

**LEGACY CHILLERS, INC. – PRODUCT DATA SHEET**