

# PRODUCT DATA SHEET

**Model: IESA62D**  
*Split-System Air-Cooled*  
*62 Ton Chiller*



**Legacy Chiller Systems**  
 851 Tech Drive  
 Telford, PA 18969  
**Toll-Free: (877) 988-5464**

**STANDARD ON ALL LEGACY MODELS:**  
 Pentra Microsmart, Programmable Logic Controller (PLC)  
 with HMI Touch Screen Display.

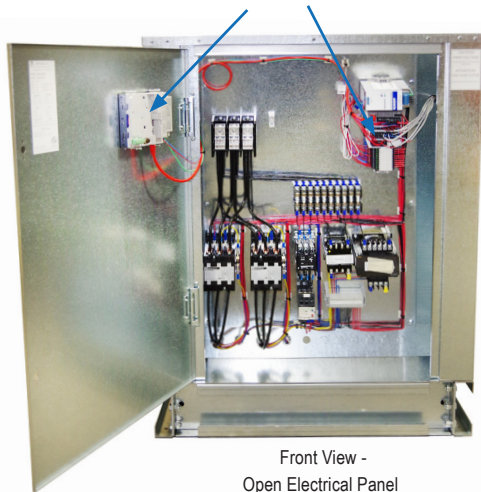

Front View -  
 Open Electrical Panel

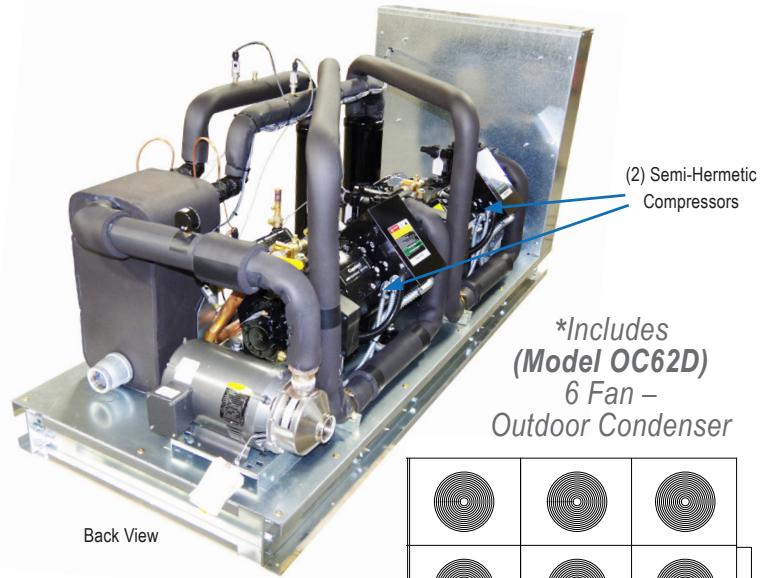

(2) Semi-Hermetic  
 Compressors

*\*Includes*  
**(Model OC62D)**  
 6 Fan -  
 Outdoor Condenser

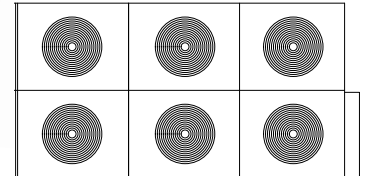

TOP VIEW

## Standard Features:

- ETL listed to UL 1995 & CAN/CSA C22.2 No. 236-11, 4th edition, 10/14/2011
- Single Point Power Connection
- Idec microprocessor controller with easy to use HMI touch screen display
- STAINLESS STEEL, brazed plate evaporator
- SEMI-HEMETIC compressor with crankcase heater and vibration spring mounting kit
- Compressor discharge and suction pipe vibration eliminators
- Suction Accumulator
- Liquid sight-glass, solenoid, TXV and replaceable core drier
- Water flow switch
- 24V control transformer
- Fan cycle control (+40°F)
- Direct drive condenser fan motor
- Rust resistant, high CFM, aluminum condenser fan blade
- Condenser(s): copper tube/aluminum fin, Floating Tube™
- **5 year condenser warranty against tube sheet leaks**
- Compressor motor contactor
- Individual condenser motor contactors and fusing
- Condenser control panel with factory mounted door interrupt disconnect switch
- Galvanized steel sheet metal cabinet
- 1/2 inch insulation on all water and refrigerant lines
- Operating Refrigerant charge from factory
- **Factory Performance Test prior to shipment**



**Easy to Use**  
**Touch Screen Display**  
 on all Legacy Chiller  
 Models

## Options:

- Remote Idec touchscreen control panel
- Industrial VPN Router
- 5 Port Ethernet Switch
- BacNet Gateway
- Process Pump VFD Controller
- 4 year extended compressor warranty
- 115 volt (rain tight) service outlet
- Non Fused Disconnect
- Phase Monitor, line voltage monitor offering protection against phase loss/reversal, unbalance and hi/lo voltage
- Compressor Sound Cover
- Flooded cond. w/receiver/head pressure control (0°F)
- Heated, flooded cond. w/receiver/head pressure control (-20°F)
- Factory installed evaporator heat tape freeze protection
- Fused, STAINLESS STEEL process pump
- Dual process pump with manual changeover
- Dual process pump with auto changeover
- Pump suction isolation valve
- Water pressure gauge set
- Water Flow Meter
- Copper finned condenser coil (coastal protection)
- BohnGuard™ coated condenser coil (coastal protection)
- Epoxy or Phenolic coated fins (coastal protection)
- Door Mounted HMI with weather proof cover

# PRODUCT DATA SHEET

Model: **IESA62D**  
*Split-System Air-Cooled*  
*62 Ton Chiller*



**Legacy Chiller Systems**  
 851 Tech Drive  
 Telford, PA 18969  
 Toll-Free: (877) 988-5464

## Indoor Chiller Dimensional & Electrical Table (Dual Circuit)

Chiller Models	Length Inches	Width Inches	Height Inches	Power			Compressor		RLA ea.	LRA ea.	Fan Motor		MCA	M.O.P	Chiller Fluid Conn.	Weight Pounds
				Voltage	Phase	Freq.	Qty.	HP			Qty.	FLA.				
IESA62DN5	110	34	62	200/230V	3	60Hz	2	35	167.9	754	6	7	450	500	2.5" MPT	2200
IESA62DP5				230V	3	60Hz			142.3	594		7	400	500		
IESA62DH5				460V	3	60Hz			71.8	297		3.5	200	250		
IESA62DI5				575V	3	60Hz			58.3	245		2.8	150	200		

## Outside Condenser Specs (OC)

Outside Condenser	Length Inches	Width Inches	Height Inches	Fan Motor		Refrigerant Conn.		Weight Pounds
				Qty.	HP	Discharge	Liquid	
<b>OC62D</b>	180	88	49.13	6	1.5	1 5/8"	1 1/8"	1990

## Capacity Table (Refrigerant R407C)

Model	Compressor	LWT °F	80°F			90°F			95°F			100°F			105°F		
			TONS	KW	EER	TONS	KW	EER	TONS	KW	EER	TONS	KW	EER	TONS	KW	EER
62D	6DJNR40ME	42.0	74.7	65.6	11.3	67.8	71.0	9.6	64.2	73.8	8.7	60.3	76.6	7.9	56.3	79.6	7.2
		44.0	78.7	66.4	11.8	71.8	71.8	10.0	<b>68.0</b>	<b>74.8</b>	<b>9.1</b>	64.0	77.8	8.3	59.8	81.0	7.5
		45.0	80.7	66.8	12.0	73.7	72.4	10.2	69.8	75.2	9.4	65.7	78.4	8.5	61.5	81.6	7.7
		50.0	90.2	78.6	13.1	82.8	74.4	11.2	78.8	77.6	10.3	74.3	80.8	9.4	69.8	84.4	8.5

*\*Includes (Model OC62D)*  
*6 Fan – Outdoor Condenser*

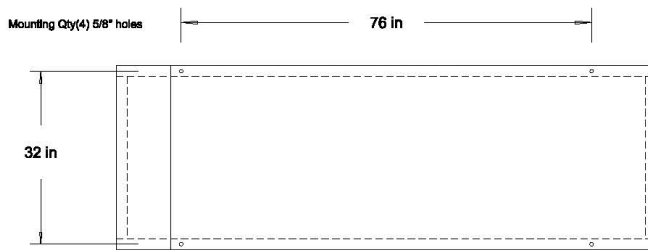

TOP VIEW

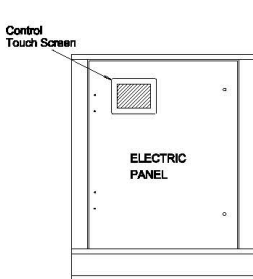

FRONT VIEW

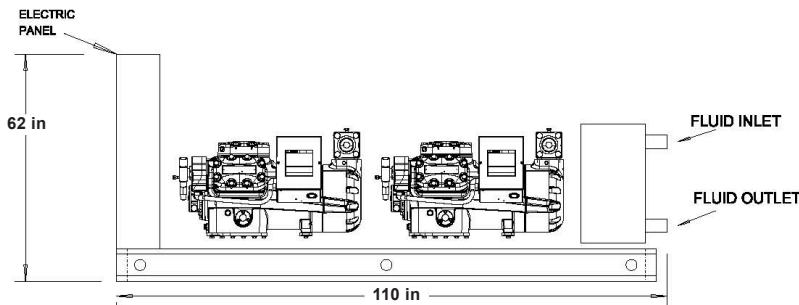

SIDE VIEW

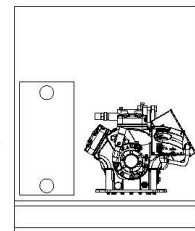

BACK VIEW