

**VALUE LINE - Package Air-Cooled
with
Integrated Tank System
VPACT
Official Submittal Documents**







Due to our policy of continuous product improvement, Legacy Chiller Systems Inc. reserves the right to make product and documentation changes without notice. Drawings in this submittal are representations of the equipment shown. Contact the factory for specific unit drawings.

TABLE OF CONTENTS





General Information	Page	Optional VPACT Add-On packages	Page
VPACT Application Markets	2	Process Drop Assembly	12
Legacy Support Services.....	3	Automatic City Water Bypass	13
Basic Chiller Sizing Formulas	4	Glycol Tables and Application	14
Legacy System Design Tools	5	1MS and 2MS System Pump Curves ...	15
Product Nomenclature	6	Factory Startup Program	
Specifications (Size, Weight, Dims, Etc.).....	7	Pricing Table	16
Capacity Tables	8	Program Benefits	17
Micro-Processor Control		Legacy Limited Product Warranty	18-20
Base Controller Summary	9		
Remote Controller Summary	10		
Remote IP Interface and Control	11		



Package Air-Cooled
with
Integrated Tank System
VPACT Application Markets

Market	Applications
<p align="center">Bio-Medical</p> <p>As medical imaging systems such as MRI and CT continue to become more powerful, demand for Mission Critical cooling systems has also increased. Legacy Chiller's VPACT line has become the standard for most major imaging system manufacturers such as GE, Seimens, Toshiba and Philips to name a few.</p> 	<ul style="list-style-type: none"> • Magnetic Resonance Imaging (MRI). • Computed Tomography (CT). • Positron Emission Tomography (PET). • Solid-state lasers. • Gas lasers. • Chemical lasers. • Metal-vapor lasers. • Hypothermia blankets.
<p align="center">SEMI- Conductors & Hi-Tech</p> <p>In 1994, Legacy Chiller Systems developed the first OEM fluid cooling system for the Hewlett Packard 83000 digital IC test platform. As the concept of fluid cooled hi-tech applications grew, Legacy's cooling solutions for this complex market also became the standard.</p> 	<ul style="list-style-type: none"> • Hewlett Packard 83000 SOC test. • Agilent 93000 SOC test. • LTX Fusion SOC test. • Semi lasers. • Advance <u>Server</u> cooling systems. • Advance <u>Router</u> cooling systems. • Controlled environment centers. • Jacket cooling.
<p align="center">Fermentation & Food Process</p> <p>The fermentation and food processing industry presents unique challenges for chiller systems and process design. Reliability is paramount where food quality and safety are concerned. Legacy Chiller Systems product lineup and manufacturing processes are ideal in this highly diverse market.</p> 	<ul style="list-style-type: none"> • Commercial wine making. • Commercial beer (WORT) making. • Climate controlled storage. • Process pre-cooling systems. • Commercial distilleries. • Commercial baking. • Commercial fishing vessels. • Fruit and vegetable washing.
<p align="center">General Purpose</p> <p>In addition to our lineup of Mission Specific OEM chiller solutions, Legacy also provides a complete line of General Purpose chillers that are easily adapted to just about any market. Using the on-line Quote Wizard system, selections are easy. If you get stuck, no problem. Just call our HELP LINE for assistance.</p> 	<ul style="list-style-type: none"> • Concrete batch plants. • Injection molding. • Welder cooling. • Oil coolers. • Press roller cooling. • Photo processing. • Commercial fish tanks. • Potable water.

Legacy Support Services

Services	Resources
<p style="text-align: center;">Legacy Help Line</p> <p>If it's your first time researching and buying a chiller, the selection process can be overwhelming especially if you have limited prior experience with chillers. Understanding these challenges, Legacy has set up a FREE Help Line where customers can get answers to basic chiller design questions and help with selections. Call Toll FREE 877-988-5464.</p> 	<ul style="list-style-type: none"> • Assistance to determine cooling needs. • Chiller type selection. • Chiller capacity selection. • Chiller pump selection. • Chiller options selection. • Answer questions about startup. • Provide maintenance information. • Basic system engineering assistance. • How to use Legacy design tools.
<p style="text-align: center;">OEM System Engineering</p> <p>Since 1994, Legacy Chiller Systems has worked with many Fortune 500 companies to design, specify and manufacture specialty OEM Mission Specific fluid cooling systems. Our design build engineering department is capable of addressing complex cooling challenges and turning these challenges into successful, cost effective projects.</p> 	<ul style="list-style-type: none"> • Semi-Conductor test. • MRI,CT,PET imaging systems. • Bio-Diesel processing. • Advanced laser applications. • Advance <u>Server</u> cooling systems. • Advance <u>Router</u> cooling systems. • Controlled environment centers. • Jacket cooling. • Injection molding applications. • Food processing.
<p style="text-align: center;">Factory Training Program</p> <p>The key to successful planning, purchase, installation and service of your chiller system is understanding how chiller system work. Legacy offers basic, as well as, advanced chiller factory training programs that cover all aspects of chillers.</p> 	<ul style="list-style-type: none"> • Chiller system design and applications. • Understanding system layout. • Closed and open loop piping systems. • Pumps and pump selection. • Proper installation practices. • Chiller system operation. • Chiller system startup/commissioning. • Chiller system maintenance. • Process fluid service and maintenance.
<p style="text-align: center;">Getting Help on the Web</p> <p>In addition to free engineering phone support, Legacy offers many web-based tools to make the chiller selection process considerably easier. We also maintain an extensive on-line KnowledgeBase system that can provide answers to most common questions.</p> 	<ul style="list-style-type: none"> • Our FREE XL based SystemSyzer software can be requested from our Quote Wizard system. • Legacy Chiller System's Sizing & Troubleshooting Slide Chart Tool. Copies can be purchased from the Legacy on-line store.



**Try the Legacy
SystemSizer**

Package Air-Cooled with Integrated Tank System Basic Chiller Sizing Formulas



**Try the Legacy
Slide Chart**

Air-Cooled Chiller Selection Procedures

To properly select an Air-Cooled condenser package chiller, the following information will be needed:

1. The required cooling BTUH.
2. Entering and leaving process fluid temperatures. Delta T = Leaving temp (Minus) Entering temp
3. Gallons Per Minute (GPM) flow rate through your process.
4. Design outdoor ambient temperature. For proper option selection you need to know highest and lowest temperatures.

Basic formulas:

1. How to determine BTUH = GPM x Delta T x 500.

Example: GPM = 10, Delta T = 15., BTUH = 10 x 15 x 500, BTUH = 75,000

2. How to determine GPM =
$$\frac{\text{BTUH}}{\text{Delta T} \times 500}$$

Example: BTUH = 75,000 , Delta T = 15., GPM = 75,000 / 15 x 500, GPM = 10

3. How to determine Delta T =
$$\frac{\text{BTUH}}{\text{GPM} \times 500}$$

Example: BTUH = 75,000, GPM = 10. , Delta T = 75,000 / 10 x 500, Delta T = 15

For applications using glycols or fluids other than water
call the HELP LINE.

Package Air-Cooled with Integrated Tank System Legacy System Design Tools

If you are not familiar with designing fluid process systems, Legacy Chillers offers two system design tools that can make this task much easier, our SystemSyzer and Slide Chart Tool.

SystemSyzer

Description: When the need to purchase a chiller comes around, getting answers to basic chiller and system design questions can turn out to be very challenging. If you are like most people, such challenges can be very time consuming without highly specialized training. Well, the Legacy SystemSyzer program can be a considerable help saving you time and money. Legacy Quote Wizard users can request and receive a FREE copy of SystemSyzer in just minutes.



**Legacy SystemSyzer
Available for FREE**

SystemSyzer Features

- Microsoft XL based.
- Menu driven and easy to use.
- Provides required chiller capacity.
- Provides header piping sizes.
- Provides branch piping sizes.
- Calculates total system pressure drop.
- Calculates total system flow rate.
- Allows for glycol adjustment.
- Calculates Legacy Economizer savings.
- Links to Legacy's on-line training system.
- SystemSyzer is FREE to Quote Wizard users.

Slide Chart Tool

Description: This easy to use slide chart tool is designed for hard work in the field helping service professionals and engineers get fast answers to chiller related challenges. Since its release in late 2007, the Legacy Slide Chart Tool has become a must have in your service vehicle or briefcase.

Added Bonus (for a limited time)

Each slide chart includes discount codes good for up to **10 % savings** on chillers and other products.



**Available
in our on-line store**

Slide Chart Tool Features

- Made with heavy high gloss card stock material.
- Provides basic refrigeration diagnosis information.
- R22, 134A, 404A, 410A and other temperature pressure charts.
- Calculate required chiller capacity.
- Perform 60 hz to 50 hz capacity adjustment conversions.
- Includes Propylene and Ethylene glycol freeze point tables.
- Includes the most common chiller related formulas and conversions.
- Calculates Legacy Economizer energy savings

VPACT DESCRIPTION

Air-cooled packaged with internal integrated plastic open vented storage tank. Outdoor weather rated construction ideal for industrial applications. Upward discharge airflow minimizes directional sound and carries heat away from surrounding areas.

FEATURES

STANDARD FEATURES:

- Micro-Processor controlled.
- Alfa Laval -316 stainless steel brazed plate evaporator with 1/2" insulation.
- Copeland Scroll compressor.
- Insulated open vented plastic storage tank .
- Fused 316 stainless steel pump system pump.
- System pump low flow bypass.
- Suction accumulator compressor protection.
- Differential pressure flow safety.
- Hot gas by-pass capacity control by Sporlan.
- Heavy duty 24v control transformer with protection fusing.
- Direct drive condenser fan motor(s).
- Rust resistant, high CFM aluminum condenser fan blades.
- Keep-Rite copper tube, aluminum condenser coils.
- "Hard Start Kit" on single phase systems.
- All type "L" copper plumbing with 1/2" insulation..
- Factory mounted casters.
- Painted galvanized sheet metal cabinet.
- Liquid line dryer, sight glass, solenoid valve and Sporlan TEV.
- Full refrigerant charge.

AVAILABLE VPACT OPTIONS:

- Coastal protected condenser coils.
- Variable condenser fan speed control - Low ambient protection to + 20°F.
- Sporlan flooded condenser - Low ambient protection to + 0°F.
- Sporlan HEATED flooded condenser - Low ambient protection to - 25°F.
- System and re-circulation pump heating system - Low ambient protection to - 32°F.
- Evaporator heat tape with thermostatic control - Low ambient protection to + 0°F.
- Compressor fusing.
- Compressor phase protection.
- Fused main line voltage service disconnect.
- 115v (rain tight) service outlet.
- Water flow meter.
- Fluid pressure gauges (in/out).
- System pump isolation valves.
- Extended Compressor warranty.
- Remote IP micro-processor controller.
- Local (wall mount) micro-processor controller.

Factory Process Loop Options:

- Wall drop assembly.
- Auto city water change over system .

NOMENCLATURE EXAMPLE

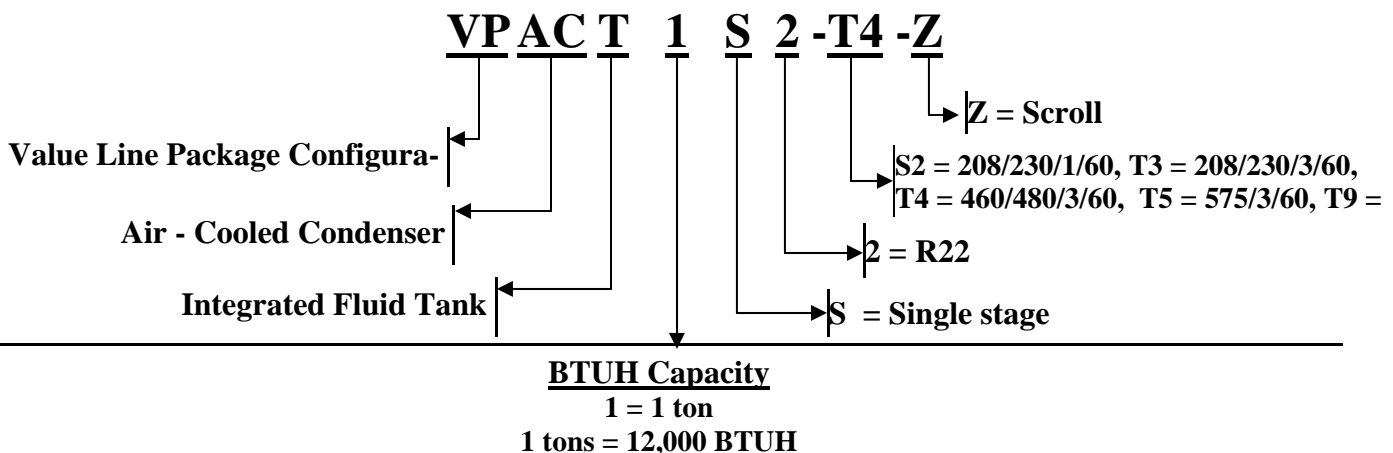

PRODUCT SPECIFICATIONS (SINGLE STAGE)

Legacy Model	BTUH @ 95°F amb. 50°F Lwt	Length Inches	Width Inches	Height Inches	PolyTank Gal.	Fluid Conn.	Compressor		RLA Ea.	LRA Ea.	Fan Motor		Chiller Pump HP	Chiller Pump FLA	MCA	M.O.P.	Weight Pounds																											
							Qty.	HP			Qty.	FLA ea.																																
1S2-S2-Z	15,600	36	40	40	6	3/4" FPT	1	1.3	10	42	1	3.3	1	8.4	25	30	350																											
2S2-S2-Z	27,600								15.7	73.0					3.3	8.4		45																										
2S2-T3-Z									2.5	8.2					63.0	3.3		8.4	30																									
2S2-T4-Z										4.3					31.0	1.6		2.0	15																									
3S2-S2-Z									39,600	20.7					127.0	3.3		8.4	50																									
3S2-T3-Z	3.5									13.9					88.0	3.3		8.4	40																									
3S2-T4-Z		7.1	44.0	1.6	2.0	15																																						
4S2-S2-Z	46,000	56	34	40	13	1" FPT	1	4	25.0	132.0	1	3.3	1.5	10.0	60	80	575																											
4S2-T3-Z									4.5	15.0								115.0	3.3	8.4	54																							
4S2-T4-Z										7.4								47.5	1.6	2.0	15																							
5S2-S2-Z	56,500								56	34								40	13	1" FPT	1	5	30.1	175.0	2	3.3	1.5	10.0	40	50	425													
5S2-T3-Z																							2.5	20.7								115.0	3.3	10.0	40									
5S2-T4-Z																								8.9								63.0	1.6	2.8	20									
6S2-T3-Z	70,000	56	34	40	13	1" FPT	1	6			20.7	156.0	2	3.3	1.5	10.0	40						50	575																				
6S2-T4-Z											2.5	11.5																				70.0	1.6	2.8	30									
7S2-T3-Z	87,600											56																				34	40	13	1" FPT	1	8	32.1	195.0	2	3.3	1.5	10.0	60
7S2-T4-Z									16.4	95.0	1.6							2.8	30																									
8S2-T3-Z	100,800								56	34	40							13	1" FPT	1	9	33.6			225.0	2	3.3	1.5	10.5	60	90						700							
8S2-T4-Z																						17.3			114.0													1.6	3.2					
10S2-T3-Z	116,000	85	31	125" FPT	10	1.6	2	10					42.0	239.0	2	3.3	1.5				10.5	70	110	750																				
10S2-T4-Z													19.2	125.0											1.6													3.2	35					

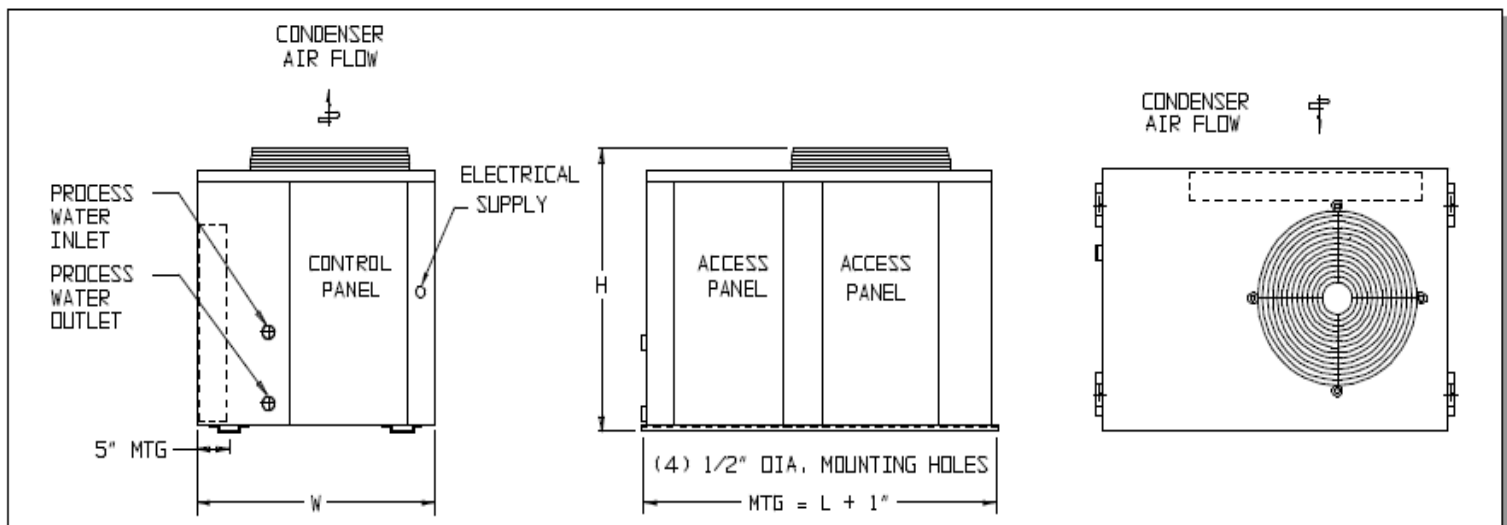

For detailed dimensional, weights, and connection drawings, see the VPACT SUPPLEMENTAL INFORMATION pages of this submittal package.

Package Air-Cooled
with
Integrated Tank System
VPACT

	VPACT1S	VPACT2S	VPACT3S	VPACT4S	VPACT5S	VPACT6S	VPACT7S	VPACT8S	VPACT10S
42	13200	24000	34400	40600	47800	59900	77000	88100	100900
44	13700	24950	35900	42000	49800	62000	79900	91200	104000
45	13900	25550	36500	42900	50800	63100	81300	93000	106300
50	15100	27650	39400	46600	55600	68500	87800	101000	115000

B
T
U
H

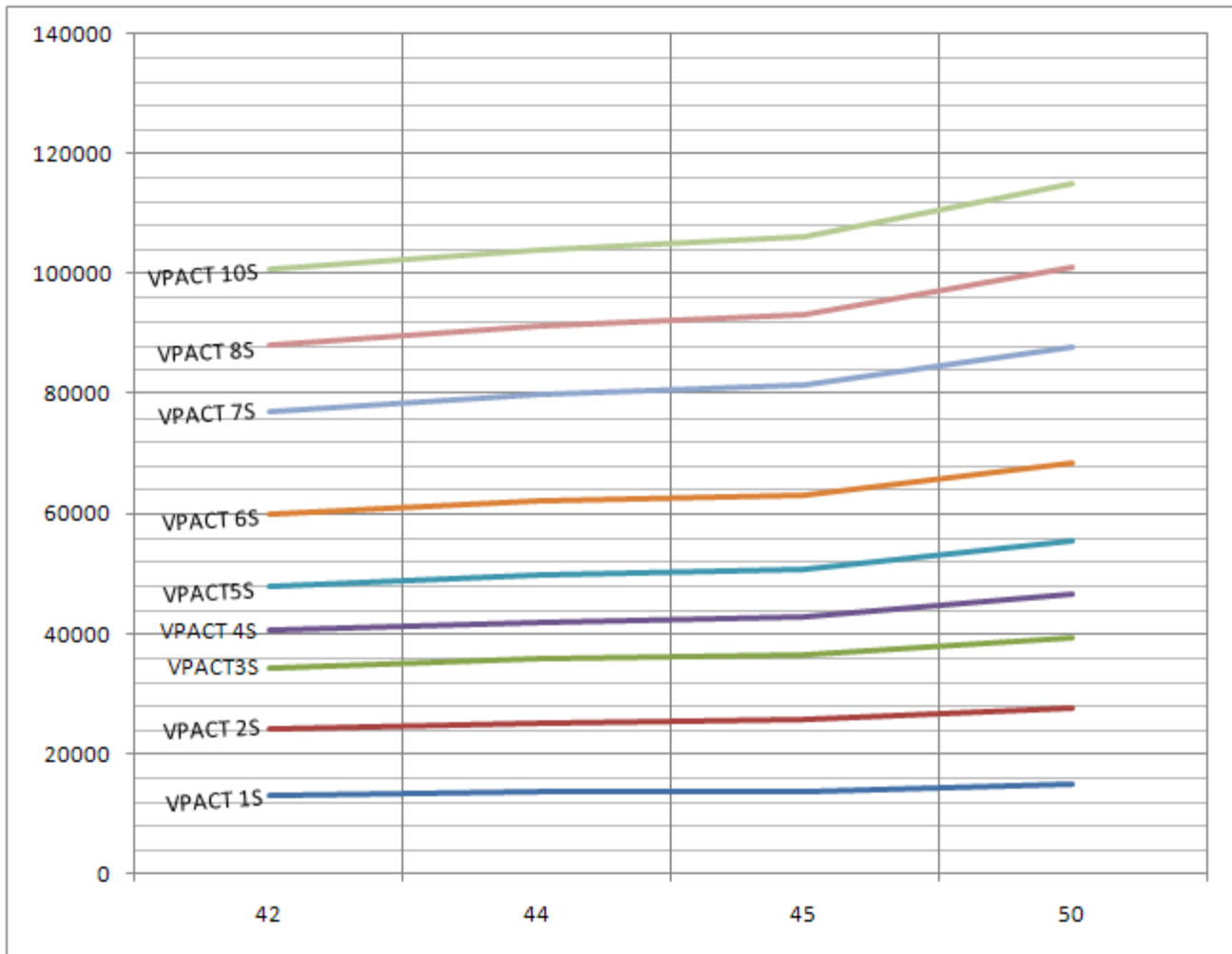

Chiller Leaving F.

Important: Capacities stated above have been calculated at the American Refrigeration Institute (ARI) standard for air-cooled condenser chillers. This standard calls for 45°F leaving the chiller at 95°F ambient temperature.

Micro-Processor Controllers Base Controller Summary

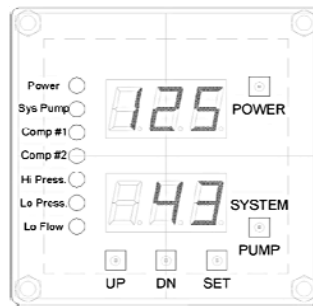

Features:

- Control operates to a +/- 1°F accuracy.
- 1 or 2 compressor control capability.
- Operates and displays in °F or °C.
- Controls chiller on inlet or outlet temperature.
- Scroll through set up and review mode.
- 30 second compressor time delay to prevent short cycling and nuisance faults.
- 60 second hot gas solenoid delay to prevent false hot gas feeding during compressor start up.
- Lock-out relay shuts down the chiller when control fault settings activate.
- Automatic compressor lead lag on dual circuit chillers.
- Weather resistant for outdoor use.
- Basic chiller functionality for ease of set up and operation.
- Factory default function code to reset the controller to the initial factory settings.
- Two L.E.D. display windows.
- Inlet & outlet temperature during chiller operation.
- Displays refrigerant high and low pressure in review mode.
- Chiller control power on/off switch with green indicator.
- System pump on/off switch with green indicator.
- Compressor run indicator lights.
- High and low refrigerant pressure red fault indicator .
- Low fluid flow red indicator.
- Display flashes all chiller faults.
- High fluid temperature outlet alarm - (display only - does not shut down the chiller).
- Low fluid temperature outlet alarm - (display only - does not shut down the chiller).
- High refrigerant pressure - (shuts down the chiller and requires manual reset).
- Low refrigerant pressure - (shuts down the chiller and requires manual reset).
- Low water flow through evaporator - (shuts down the chiller and automatically resets when flow is restored).

For more detailed information on Micro-Processor operation please consult the Scroll Series Installation Operations Guide.

Micro-Processor Controllers Remote Controller Summary



Wall Mounted REMOTE
Micro-Processor
(Optional)

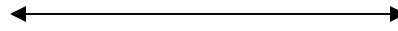

Cat 5 connection cable
Standard cable 100'
(Max cable length 500')



VPACT with HOST
Micro-Processor
(Standard)

General Description: The Legacy remote micro-processor is a self powered device. This device makes remote operation of the chiller possible from up to 500 feet away. Interface is password protected with the same review and user functions available at the host chiller's interface. This device is ideal for project sites where adverse weather conditions can interfere with set-point changes needing to be made.

Operation: After the proper clearance code has been entered on the remote device the operator can either review or make adjustments to the chiller's operating parameters at any time. The ability to make program changes remotely is ideal for colder climates or sites where the chiller is not easily accessible.

Distances: The optional remote controller comes with a 100' Cat 5 interface cable. Customers who need additional cable can purchase an upgraded 500' interface cable. Extending the interface cable over 500' is not recommended.

Power Requirements: The optional remote controller is completely powered by the chiller's single point wiring connection and internal control transformer. Connection of the CAT 5 interface cable between the chiller's host micro-processor and the remote control unit is the only connection needed. No additional power connections are required.

Installation: The remote controller (above left) comes encased in a heavy duty, splash resistant, metal enclosure. The most common installation for this device is on a wall surface easily accessible to chiller operator.

Alarms: Alarms are shown exactly as they are shown on the host chiller controller. The remote display unit will also sound a buzzer at 50% duration while the alarm is active. If during this time the "up" key is pressed, the buzzer will be silenced for 10 minutes while still in the same alarm. If another different alarm occurs within those 10 minutes then the buzzer would sound again. If after 10 minutes of silence the error still exists the buzzer will sound again. If applicable to the particular alarm, momentarily pressing the power key will clear the error and silence the buzzer. Alarm relay on the Legacy remote display unit will function the same as the Legacy chiller controller.

For more detailed information on optional remote controller operation please consult the Scroll Series Installation Operations Guide.

Micro-Processor Controllers Remote IP interface and Control

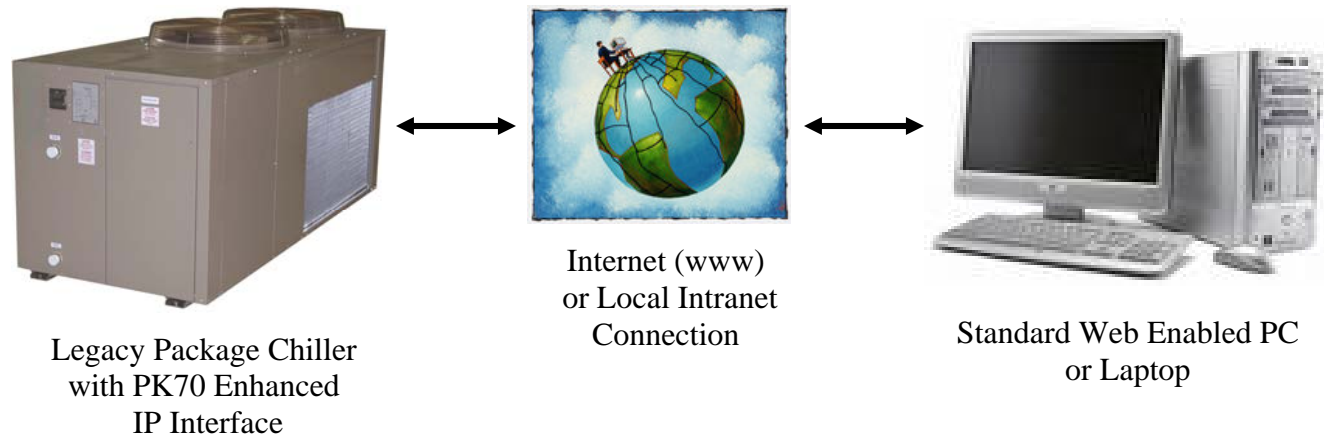

General Description: The optional Legacy PK70 enhanced IP interface offers customers the ability to administer all chiller operational functions using local Intranet or remote Internet connections.

Operation: The optional Legacy PK70 provides a self hosted web page interface with easy to use point and click functionality. Once the user has logged into the PK70 interface using a standard web browser, a multitude of chiller functions are at your finger tips.

Basic PK70 Interface Control Points Include:

- Review and programming level security modes with encrypted password protection.
- Set-point review or edit.
- Alarm history review.
- Alarm trigger edit.
- Alarm email notification edit.
- Cooling performance trending.
- Remote shutdown.

Power Requirements: The PK70 is completely powered by the chiller's single point wiring connection and internal control transformer.

Installation: An RJ-45 Ethernet socket connection is provided on all chillers with equipped with the IP interface option. Customers who have site firewalls or other network protection systems running will require some network administration support to allow for PK70 connection to your network. LEGACY CHILLER SYSTEMS INC. DOES NOT OFFER SUPPORT FOR YOUR LOCAL NETWORK.

Release: Legacy Chiller Systems Inc. anticipates availability of this option in the fourth quarter, 2008. Once released, Legacy will also be offering an upgrade package for all current micro-processor equipped chillers.

For more detailed information on Remote IP access / control operation please consult the Scroll Series Installation Operations Guide.

Legacy Optional WALL DROP Assembly

Wall Drop Assembly Description: Free supporting hydronic process connection point designed for easy field installation for Mission Critical fluid cooled applications. Wall Drop Assembly comes fully equipped with all valves, filters, flow measurement, pressure measurement, and temperature measurement items needed.

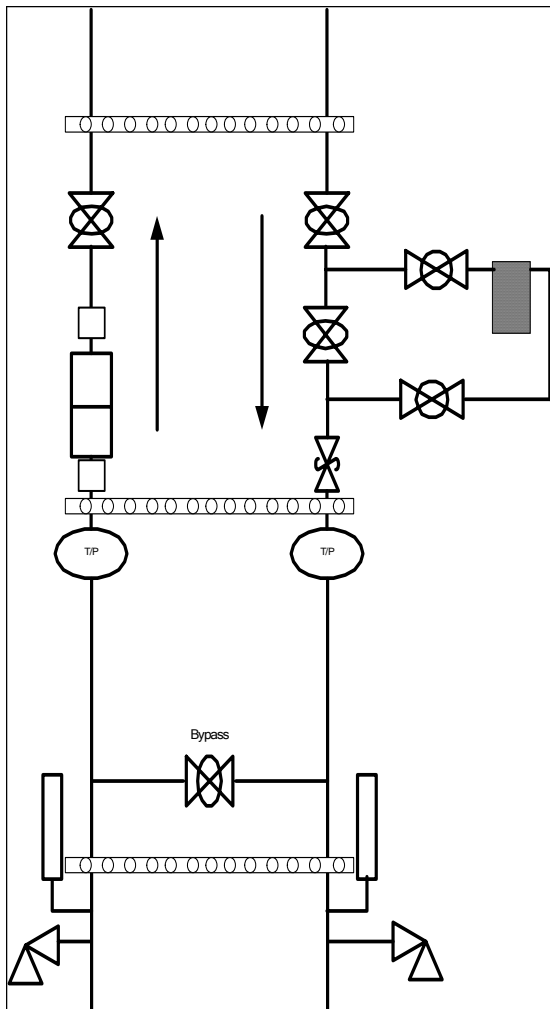

Features:

- All 1" Type L copper construction.
- Jomar "Slow Ball" hand operated ball valves with ball position indicator.
- Secured with three heavy steel pre-punched uni-strut with rubber isolators.
- Process inlet filter bypass for easy filter media replacement.
- Big-Blue filter housing with standard 50 Micro pleated filter. Filter housing tool provided with each drop.
- B & G supply circuit setter with pressure ports.
- Supply and return combination temperature - pressure gauges.
- Supply and return water hammer arrestors.
- Supply / return bypass for easy branch pressure / flow adjustments.
- Supply and return hose bibb valves with brass seal caps provided for easy process drain down.
- Blue and white flow meter with stainless steel slide. Flow ranging GPM and LPM. Standard flow scale 0-10 GPM .
- Dielectric unions at flow meter inlet and outlet for easy servicing.
- Each assembly is factory tested with compressed air to 75 PSI.

Other Information:

- Custom wall drop assemblies available upon request .
- Replacement filter media can be purchased at www.legacychillers.com .
- This item is normally in stock
- Pricing available through Legacy on-line store or Legacy Quote Wizard System

Dimensional Information:

- **Height:** Approximately 80"
- **Width:** Approximately 24"
- **Weight:** Approximately 75 LBS
- Supply and return process connections are 1" FIP.
- Recommended to mount assembly no less than 20" from finished floor.

Legacy Optional Auto City Water Bypass Assembly

Automatic City Water Bypass Description: Wall mounted, automatic emergency city water bypass system. Panel is powered by VPACT or EST package chiller system. In the event of power failure or chiller fault, panel will isolate the process chiller loop and begin cooling process with city water. This system is ideal for Mission Critical applications. Available in filtered and non-filtered configurations.



**Legacy Wall Mounted
Automatic City Water Bypass Panel**

Features:

- All 1" Type L copper construction.
- Designed for low pressure drop.
- Powered by VPACT or EST control system. **No external power needed.**
- Single point electrical connections. Some field wiring between chiller and panel is required.
- Rapid cycle industrial grade 24v solenoid valves.
- Internal city water supply strainer to protect process.
- Standard copper FIP process fluid connections.
- Heavy gauge galvanized steel enclosure.
- Internal fluid check valve preventing backflow.
- Models with internal process filter available.

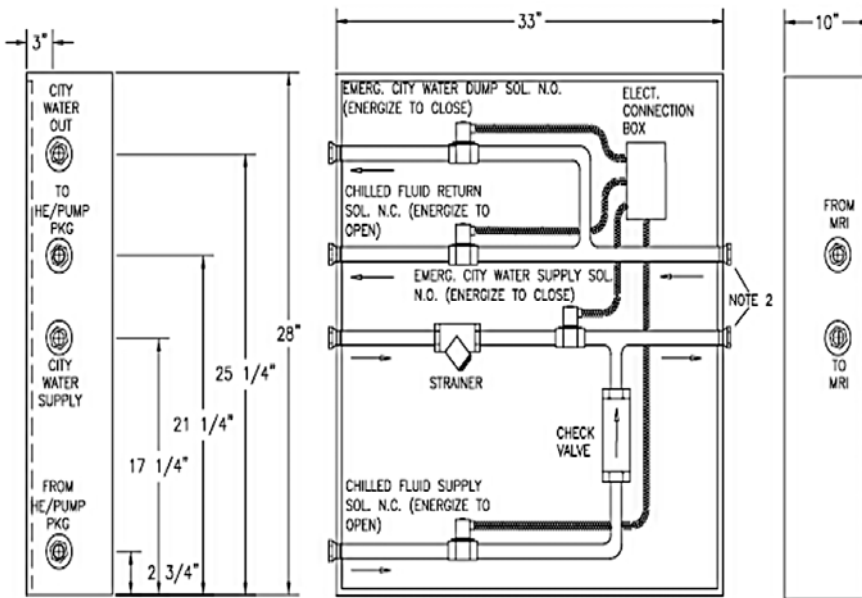

**Automatic City Water Bypass Panel
Internal Piping Configuration
(Filterless model shown)**

Dimensional information:

- **Height:** Approximately 28"
- **Width:** Approximately 33"
- **Depth:** Approximately 10"
- **Weight:** Approximately 75 LBS
- Supply and return process connections are 1" FIP.
- Panels with internal filtration system are larger.

Custom designed Automatic City Water Bypass systems are available upon request. For more information, please contact Legacy Chiller Systems HELP LINE at the number below for immediate assistance.

Package Air-Cooled
with
Integrated Tank System

Glycol Tables

Percent Propylene Glycol by Weight	15%	20%	25%	30%	35%	40%	50%
Freezing Point In °F	24°	18°	15°	9°	5°	- 5°	- 30°
Capacity Factor Multiplier *	0.992	0.986	0.972	0.960	0.950	0.928	0.878
Pressure Drop Multiplier	1.04	1.08	1.13	1.21	1.26	1.47	2.79

Percent Ethylene Glycol by Weight	10%	15%	20%	25%	30%	35%	40%
Freezing Point In °F	25°	21°	17°	11°	5°	0°	-10°
Capacity Factor Multiplier *	0.98	0.96	0.95	0.93	0.92	0.91	0.89
Pressure Drop Multiplier	1.08	1.11	1.16	1.21	1.27	1.32	1.38

IMPORTANT INFORMATION

The above tables are for general reference only. ALWAYS refer to the glycol manufacturers technical documentation for proper concentrations and safe usage of their product.

*For help with glycol factor calculations, consider purchasing a Legacy Slide Tool Chart.

All Legacy Chiller Systems are tested and shipped calibrated for water only. If your operating environment requires the use of glycol, your chiller will need to be field calibrated to safely operate using glycol. Legacy Chiller Systems provides an on-line KnowledgeBase system with complete instruction on how to perform glycol setup on all Legacy brand chillers. For more information go to: www.legacychillers.com and search the Knowledgebase for articles pertaining to "Adding Glycol".

For Best Results

Always use Legacy brand refrigeration grade glycols.

Standard Available Stainless Steel Process System Pumps

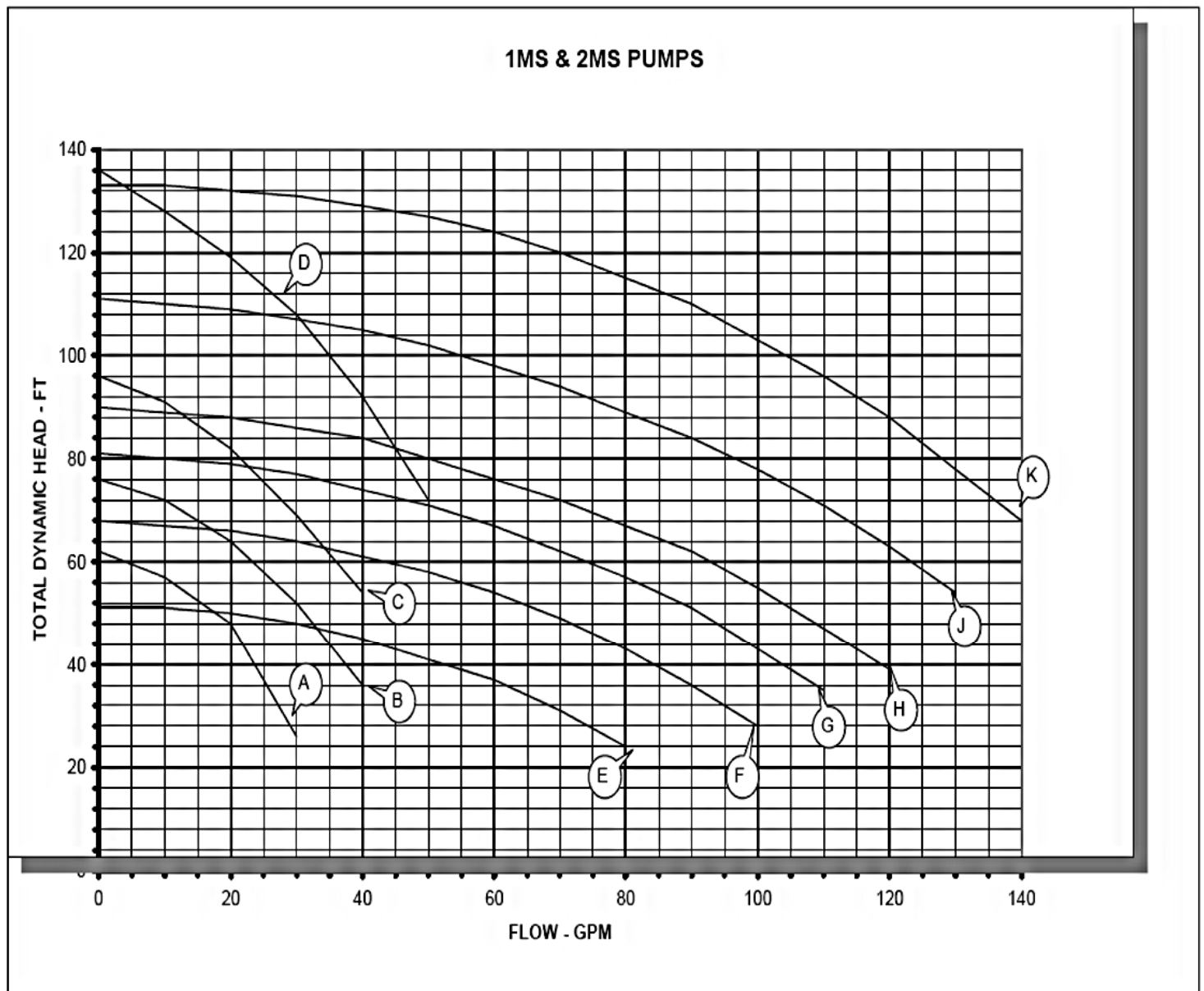

- | | | | | |
|--------------|----------------|--------------|----------------|------------|
| A) 1/3HP 1MS | C) 3/4HP 1MS | E) 3/4HP 2MS | G) 1-1/2HP 2MS | J) 3HP 2MS |
| B) 1/2HP 1MS | D) 1-1/2HP 1MS | F) 1HP 2MS | H) 2HP 2MS | K) 5HP 2MS |

** Legacy chillers are not limited to the pumps shown on this curve. Contact the factory @ (877) 988-5464 with the flow and head pressure requirements to have the proper pump selected for your application.

Certain applications may require the use of glycol (antifreeze) depending on cooling requirements and / or low ambient temperatures. These fluids affect chiller capacities and may require heat exchanger adjustments. Please consult the factory for assistance.

Factory Startup Program

Startup and commissioning of your new Legacy equipment should only be performed by a chiller qualified technician. If this is your first Legacy startup, we highly recommend investing in a Factory Startup.

In the table below, you will find our standard daily rates for factory startup service that is available in most U.S. and Canadian Markets:

PACKAGE AIR/WATER COOLED (PAC / PACT / PWC / PWCT)				
Staging	Tonnage Range	Daily Startup Rate	Estimated Days Required	Estimated Startup Service
Single Stage	1-5	1,525.00	1.0	1,525.00
	6-10	1,625.00	1.0	1,625.00
	12-15	1,725.00	1.0	1,725.00
	16-25	1,825.00	1.0	1,825.00
	26-40	1,850.00	1.5	2,775.00
Dual Stage	6-10	1,675.00	1.0	1,675.00
	12-15	1,775.00	1.0	1,775.00
	16-25	1,775.00	1.0	1,775.00
	26-40	1,875.00	1.5	2,812.50
	41-50	1,925.00	1.5	2,887.50
	51-60	1,975.00	1.5	2,962.50
	61-80	1,995.00	2.0	3,990.00
	81-100	2,025.00	2.0	4,050.00

SPLIT CONDENSER (ES / EST)				
Staging	Tonnage Range	Daily Startup Rate	Estimated Days Required	Estimated Startup Service
Single Stage	1-5	1,677.50	1.0	1,677.50
	6-10	1,787.50	1.0	1,787.50
	12-15	1,897.50	1.0	1,897.50
	16-25	2,007.50	1.0	2,007.50
	26-40	2,035.00	1.5	3,052.50
Dual Stage	6-10	1,842.50	1.0	1,842.50
	12-15	1,952.50	1.0	1,952.50
	16-25	1,952.50	1.0	1,952.50
	26-40	2,062.50	1.5	3,093.75
	41-50	2,117.50	1.5	3,176.25
	51-60	2,172.50	1.5	3,258.75
	61-80	2,194.50	2.0	4,389.00
	81-100	2,227.50	2.0	4,455.00

Important: Rates above do NOT include travel expenses. Your final billing will include additional charges for travel costs such as (but not limited to): air fare, hotel, rental car and, in some cases, truck service charges. Rates are based on "straight time" work hours Monday - Friday from 8:00 AM - 4:30 PM. If startup is required during a U.S national holiday, weekend, after hours or requires international travel the above daily rates will be increased by 1.5% .

Factory Startup Program**ADDITIONAL BENEFITS FOR YOUR FACTORY STARTUP INVESTMENT**

Investing in Factory Startup is a smart choice. Legacy Chiller Systems offers the following cost savings and convenience benefits for Factory Startup Customers:

1. TOLL FREE engineering level telephone support M-F 8:00 AM - 5:00 PM **for 24 months from startup** date.
2. On-line store promotional code valid for twelve months offering an instant 5% discount on purchase of all products offered within the store.
3. Legacy Quote Wizard system promotional code valid for twelve months offering an instant 5% discount on purchase of a chiller.
4. Extended labor allowance on your Limited Manufacturer's Warranty. **See Extended Factory Warranty section of this booklet.**

To Request Factory Startup: Availability of factory startup service can vary depending on when service will be needed and your geographic location. When ordering service:

1. A purchase order must be on file with Legacy at least 30 days prior to your estimated startup date. In order to be processed, your PO must include: bill to, ship to, daily rate, (according to the rate table on the previous page), and site contact information. A line item on the PO indicating "PLUS TRAVEL COSTS" must also be indicated. Open credit accounts will be charged after service is rendered. COD accounts will be charged to VISA or MASTERCARD ten days prior to service. COD accounts must provide credit card information at the time of PO submission to prevent scheduling delays. **Important: PLEASE make sure that all contact information provided on your PO is complete and correct. Failure to do so can impact scheduling.**
2. A completed "**Startup Request Form**", (located in the back of this booklet), must be completed and returned to Legacy no less than seven business days prior to your required startup date. Completed forms can be sent to Legacy by fax: 240-214-8303 or Email: Support@legacychillers.com. After faxing your form to us, we recommend that you call our office at 877-988-5464 within 24 hours to confirm receipt. **Important: PLEASE make sure that all contact information provided on your Startup Request Form is complete and correct. Failure to do so can impact scheduling.**
3. Approximately 72 hours prior to startup, a Legacy service advisor will attempt contact using the information provided on your PO and Startup Request Form. At that time, the startup site information will be verified and we will confirm that your system is ready for startup. If our service advisor is not able to make contact within 48 hours of startup, service will be postponed until contact is made. **Important: A reschedule charge of \$250.00 will apply if we are not able to confirm startup within 48 hours dispatch to the startup site.**

NEED MORE INFORMATION ON OUR STARTUP SERVICES?

CALL

877-988-5464

Legacy Chiller Systems Limited Factory Warranty

STANDARD Warranty: Offered on all models.

General Qualifications for Coverage:

1. The chiller has been properly installed according to factory recommendations and acceptable industry standards and local codes.
2. Chiller has been properly field started and commissioned in accordance with factory recommendations.
3. A completed startup report (located within this booklet) has been completed, signed and faxed back to Legacy Chiller Systems Inc.
4. The application of the chiller is one for which it is properly suited and sized.
5. The chiller has NOT experienced freight damage.
6. Customers account must be current. Credit terms for each transaction are stated on your Factory Order Confirmation.
7. Legacy Chiller Systems Inc. may, at its own discretion, require a second opinion for warranty by its own contractor. If an Authorized Legacy Chiller Systems Inc. service technician is available, Legacy Chiller Systems Inc. may require the repairs or a post repair inspection be performed on the equipment at the factory's expense.

STANDARD Parts Coverage: For a period of **1 YEAR** from verified startup or **14 MONTHS** from shipment, whichever is less, Legacy Chiller Systems Inc. will exchange a factory installed part for reason of a factory confirmed defect in workmanship or material failure.

STANDARD Parts Coverage Details:

1. Prior to shipment of a replacement part, customer must issue a PO (or provide Visa / MasterCard information) to Legacy Chiller Systems Inc. Legacy Chiller Systems Inc. will process billing for the item(s) on a COD or terms basis.
2. ALL warranty exchange parts must be returned to: **Legacy Chiller Systems, Inc. 484 Main Street #1, Diamond Springs, CA. 95619** within **30 DAYS** of shipment. Failure to do so will result in NON-COVERAGE of outstanding items.
3. Prior to return shipping, all item(s) must have a Return Materials Authorization (RMA) number. You must indicate RMA number, as well as the base unit's Model and Serial number on the return item(s). Failure to do so will delay warranty coverage approval.
4. The customer is responsible for all freight charges. Outbound freight charges will be billed to customers open account or charged COD at the time of shipment. All return parts will be shipped to the above address prepaid. **Important: Unless specified in writing to the contrary, all outbound shipments will be considered urgent and will be shipped out Next Day Air.**
5. You will be billed the list price for the replacement part plus applicable shipping charges. Once the original part is received and warranty verified, the customer's account will be credited for the part only. In the event the warranty claim is not valid, the customer will be expected to pay for the part within 15 days from the date of the original invoice.

STANDARD Labor Allowance Coverage: For a period of **30 DAYS** from verified startup or **45 DAYS** from shipment, whichever is less, Legacy Chiller Systems Inc. will provide labor allowance coverage for reason of a factory confirmed defect in workmanship or material failure repairs. The maximum allowances are provided on the table labeled "**Factory Labor Allowance Chart**" within the Legacy Chiller System's IOM booklet. Copies of the IOM booklet can be downloaded from our KnowledgeBase system.

STANDARD Labor Allowance Coverage Details:

1. In order to qualify for labor allowance coverage, you must have a valid Legacy PO# issued prior to starting work on subject chiller. The amount of labor charged must match the amount of the PO allowance.
2. Should additional covered repairs come up during the course of performing an approved repair, technicians must call in for additional authorization as needed after the initial PO has been issued. Failure to do so will result in the return of the unpaid invoice or an invoice short paid.
3. Maximum travel time ROUND TRIP for warranty repairs is **TWO HOURS**.
4. TRUCK charges for warranty repairs are NOT covered under Legacy Chiller Systems Inc. Limited Warranty.

Legacy Chiller Systems Limited Factory Warranty

STANDARD (NON OEM) Phone Support: For a period of **30 DAYS** from verified startup or **60 DAYS** from shipment, whichever is less, Legacy Chiller System Inc. will provide TOLL FREE engineering level phone support for chiller or chiller application questions. Company engineering support staff, (or subcontractors), do NOT warrant support information provided, should direct or indirect property damage occur. Important: **Once the Standard Phone Support period expires, fee based phone support will be available. Rates for fee based support can vary depending on the level of support needed.**

STANDARD Compressor Coverage: Legacy Chiller Systems Inc. offers both standard and optional extended compressor warranties on most models of chillers.

STANDARD Compressor Coverage Details:

- 1. Standard Copeland Scroll Compressor Coverage:** All Copeland Scroll compressors are warranted for **18 MONTHS** from date of manufacture at Copeland. **Should a compressor of this type fail within the Copeland warranty period, warranty exchange for the compressor must be processed through your local authorized Copeland reseller.** When contacting your local authorized Copeland reseller make sure to have the compressor's model and serial information available so warranty can be verified.
 - 2. Standard Copeland SEMI-HERMETIC Compressor Coverage:** All Copeland Semi-Hermetic compressors are warranted for **12 MONTHS** from date of manufacture at Copeland. **Should a compressor of this type fail within the Copeland warranty period, warranty exchange for the compressor must be processed through your local authorized Copeland reseller.** When contacting your local authorized Copeland reseller, make sure to have the compressor's model and serial information available so warranty can be verified.
 - 3. In some cases, your local Copeland reseller may charge services fees for freight and other services in relation to a compressor exchange. Legacy Chiller Systems Inc. does not cover such charges as part of our Limited warranty.**
-

OPTIONAL FOUR YEAR EXTENDED Compressor Warranty Procedure: General Statement: Extended compressor warranty coverage obligates Legacy Chiller Systems, Inc. to exchange, (FOB) the factory, the compressor with a comparable compressor with equal capacity. Legacy Chiller Systems, Inc. assumes no responsibility for accessories, labor, or freight to or from the factory. Legacy Chiller Systems, Inc. reserves the right to replace in warranty defective parts from its factory. Any unauthorized substitutions of Legacy Factory parts voids the Optional Extended Compressor Warranty. **Optional Extended Compressor Warranties must be purchased prior to shipment. Pricing is available within the On-Line Quote Wizard system or through your Legacy sales representative.**

OPTIONAL EXTENDED Compressor Warranty Procedure Details:

- All extended warranty compressors are processed through the Legacy factory.
- To receive an OEM replacement compressor, a PO for the list price of the compressor is to be issued to Legacy Chiller Systems, Inc. Legacy will produce a billing or VISA / MASTERCARD charge for the cost of the compressor plus freight.
- Copeland Scroll compressors:** The original Copeland nomenclature sticker from the compressor body must be returned to Legacy within **30 DAYS** of the replacement compressor shipment to receive credit.
- Copeland Semi-Hermetic compressors:** Must be returned to the factory within **30 DAYS** replacement compressor shipment to receive credit. Return compressors are to be shipped pre-paid.
- Any questions pertaining to Extended Compressor Warranties are to be directed to Legacy Customer Service.

IMPORTANT: If your chiller is still within a labor allowance warranty period, you MUST contact Legacy Chiller Systems Inc. for a labor allowance PO BEFORE starting work. Failure to do so will result in forfeit of labor allowance coverage for the compressor replacement.

Legacy Chiller Systems Limited Factory Warranty

EXTENDED Warranty.

General Qualifications for Coverage:

1. All qualifications for "Standard Warranty" must be met to qualify for Extended Warranty benefits. See prior pages in this booklet
2. Factory Startup Service has been performed on subject system.
3. If Factory Startup Services has NOT been provided, customer may purchase an extended warranty on most models. For more information regarding purchase of an extended warranty ask your Legacy sales representative.

EXTENDED (NON OEM) Phone Support: For a period of **24 MONTHS** from verified startup, Legacy Chiller Systems Inc. will provide TOLL FREE engineering level phone support for chiller or chiller application questions. Company engineering support staff (or subcontractors) do NOT warranty support information provided, should direct or indirect property damage occur. **Important:** Once the **EXTENDED Phone Support period expires, fee based phone support will be available. Rates for fee based support can vary depending on the level of support needed.**

EXTENDED Parts Coverage: For a period of **2 YEARS** from verified startup or **36 MONTHS** from shipment, whichever is less, Legacy Chiller Systems Inc. will exchange an original factory installed part for reason of a factory confirmed defect in workmanship or material failure.

EXTENDED Parts Coverage Details: All conditions of "STANDARD Parts Coverage" apply.

EXTENDED Labor Allowance Coverage: For a period of **1 YEAR** from verified startup or **18 MONTHS** from shipment, whichever is less, Legacy Chiller Systems Inc. will provide labor allowance coverage for reason of a factory confirmed defect in workmanship or material failure repairs. The maximum allowances are provided on the table labeled "**Factory Labor Allowance Chart**" within the Legacy Chiller System Inc.'s IOM booklet. Copies of the IOM booklet can be downloaded from our KnowledgeBase system.

EXTENDED Labor Allowance Coverage Details: All conditions of "STANDARD Labor Allowance Coverage" apply .